

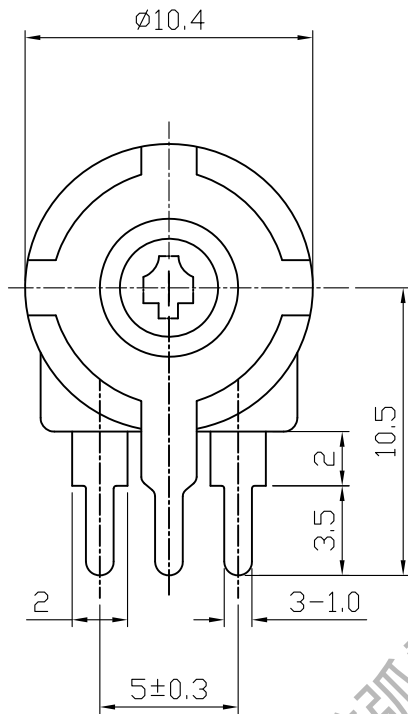

# 外形圖 Mechanical Dimensions

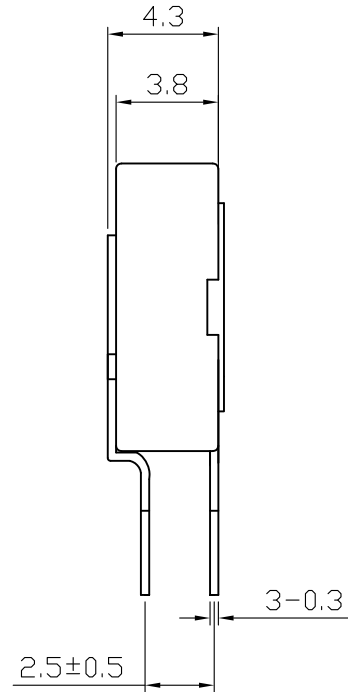

安裝孔位置圖  
Mounting Hole



接線圖  
Circuit Explanation

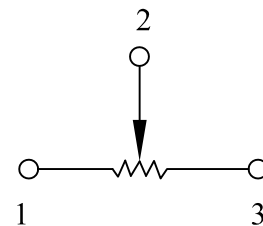
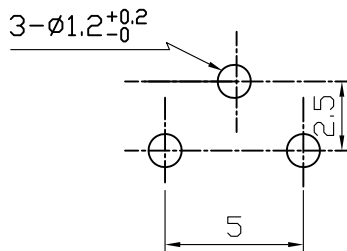

東莞市雅弧電子有限公司 DongGuan YaHu Electronic Co.,Ltd.				PRODUCT NAME		Spanish Potentiometers			
2				MODEL NAME		SB103-1-			
1				APPROVED BY		CHECKED BY			
NO	DATE	DESCRIPTION		DRAWN BY		R&D			
DIMENSION		TOLERANCE	SCALE			2011.09.22			
$l \leq 10$		$\pm 0.2$	UNIT			mm		Lucky	
$10 < l \leq 30$		$\pm 0.5$	VER.						
$30 < l \leq 100$		$\pm 1.0$	DATE	2007/06/01					



# 一、微調電阻系列技術規格書

Common Specification For Semi-Fixed Potentiometers

1. 電器性能 (Electrical Characteristic)					
序号	項目			特性	
1.1	全阻抗值 (Total Resistance)			1KΩ ~ 2M	
1.2	全阻抗值允許偏差 (Total Resistance Tolerance)			± 20%	
1.3	阻值變化特性 (Resistance Taper)			A, B	
1.4	零位阻值 (Residual Resistance)			Term 1~2: Less than 20Ω Term 2~3: Less than 20Ω	
1.5	額定功率 (Rated Power)			Carbon Film Type 0.15W	
1.6	最高使用電壓 (Max. Operating Voltage)			DC 200V	
1.7	耐電壓 (Withstand Voltage)			1 minute at DC 200V	
1.8	耐溫特性 (Temperature Characteristic)			-25℃ ~ 70℃ : ΔR/R ≤ ± 8%	
1.9	潮濕環境下負載性能 (Load Life In Humidity)			<u>20%</u> Max <u>350</u> hours rated in <u>90%RH 40℃</u>	
2. 機械性能 (Mechanical Characteristics)					
2.1	全回轉角度 (Rotation Angle)			235° ± 10°	
2.2	旋轉力矩 (Rotation Torque)			10 ~ 150gf.cm	
2.3	轉動止檔強度 (Rotational Stop-End Torque)			≥ 0.5Kgf.cm. max	
2.4	焊錫耐熱性 (Resistance to soldering heat)			<u>260 ± 5</u> ℃ and less than <u>3 ± 1</u> seconds	
3. 耐久性能 (Durability)					
3.1	回轉壽命 (Rotation Life)			10,000 cycles min	
4. 外形尺寸圖/曲線特性圖 (Shape size drawing/curve characteristic drawing)				見附頁 (Please see attachment)	
5					
批 准		審 核		設 計	



# RESISTANCE TAPER

TAPER B SERIES

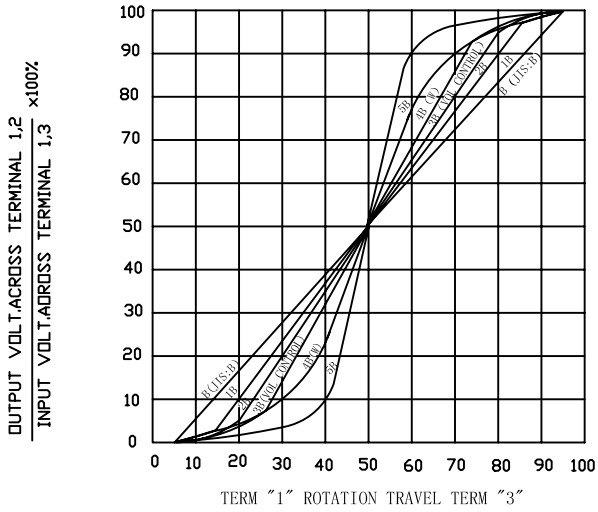

TAPER B WITH 50% TAP

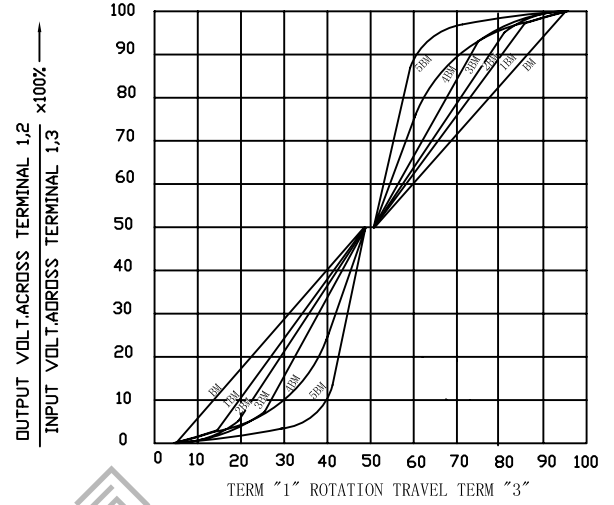

TAPER A SERIES

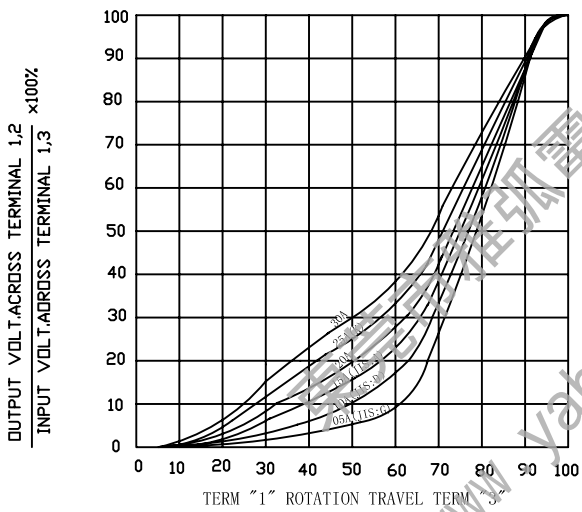

TAPER A & C WITH 50% TAP

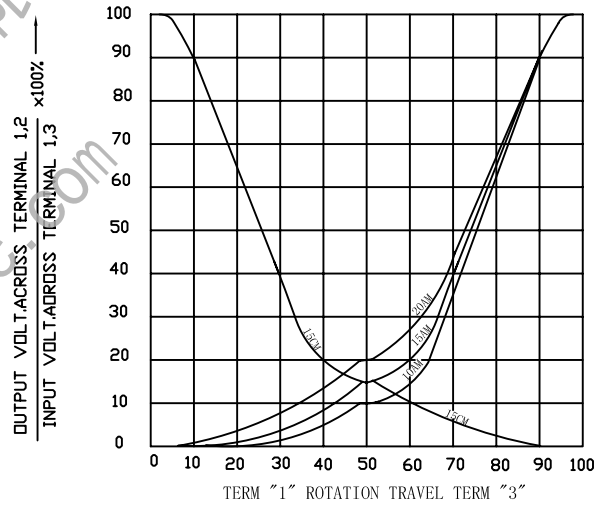

TAPER C SERIES

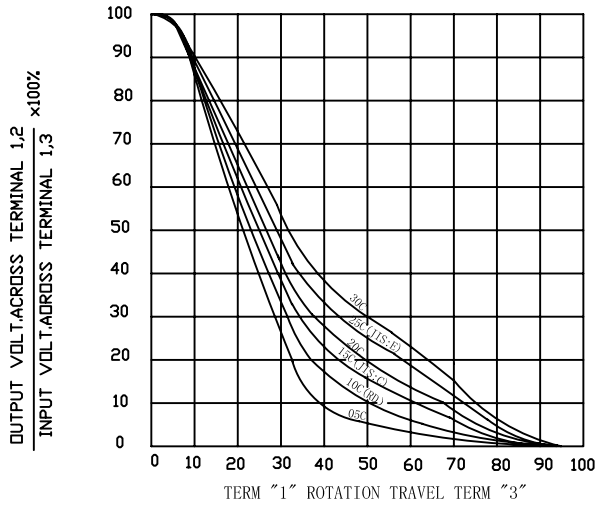

TAPER M & N SERIES

