



一、微調電阻系列技術規格書

Common Specification For Semi-Fixed Potentiometers

1. 電器性能 (Electrical Characteristic)					
序号	項目			特性	
1.1	全阻抗值 (Total Resistance)			10 Ω ~ 5M Ω	
1.2	全阻抗值允許偏差 (Total Resistance Tolerance)			± 10%	
1.3	終端電阻 (Absolute Minimum Resistance)			≤ 1%R 或 10 Ω	
1.4	阻值變化特性 (Resistance Taper)			B	
1.5	額定功率 (Rated Power) 315 Volts max			0.85W at 70°C, 0W@125°C	
1.6	耐電壓 (Withstand Voltage)			640V AC	
1.7	溫度變化 (Temperature Variation)			-55°C, 30min, +125°C 30min 循環 5 次 R ≤ 8%R, (Uab/Uac) ≤ 8%	
1.8	溫度係數 (Temperature Coefficient)			± 300ppm/°C	
1.9	絕緣電阻 (Insulation Resistance)			≥ 100M Ω (AC100V)	
1.10	溫度範圍 (Temperature Range)			-55°C ~ 125°C	
2. 機械性能 (Mechanical Characteristics)					
2.1	有效行程 (Effective Travel)			%&w &tturns nom	
2.2	旋轉力矩 (Rotation Torque)			≤ 35mN.m	
2.3	振動 (Vibration)			ΔR ≤ 5%R, Δ (Uab/Uac) ≤ 5%	
2.4	焊錫耐熱性 (Resistance to soldering heat)			245 ± 5°C and less than 3 seconds	
3. 耐久性能 (Durability)					
3.1	回轉壽命 (Rotation Life)			200cycles	
4. 外形尺寸圖/曲線特性圖 (Shape size drawing/curve characteristic drawing)				見附頁 (Please see attachment)	
批 准		審 核		設 計	





外形圖 Mechanical Dimensions

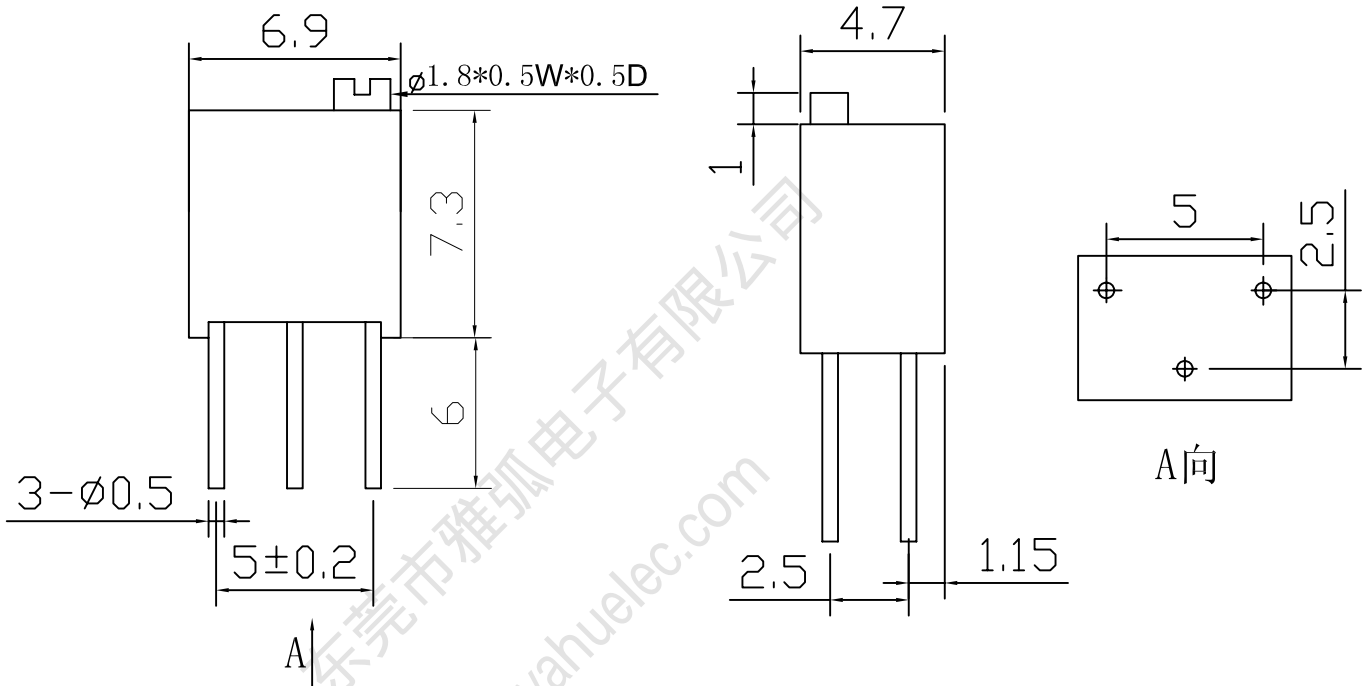

安裝孔位置圖
Mounting Hole

接線圖
Circuit Explanation

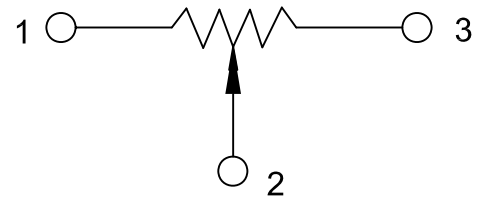
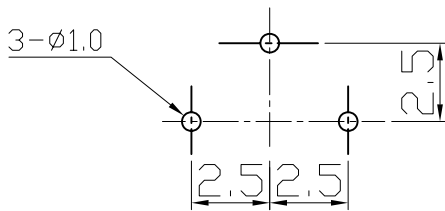

東莞市雅弧電子有限公司 DongGuan YaHu Electronic Co.,Ltd.				PRODUCT NAME	Trimmer Potentiometers	
2				MODEL NAME	JM3266-W-Value	
1				APPROVED BY	CHECKED BY	DRAWN BY
NO	DATE	DESCRIPTION				
	DIMENSION	TOLERANCE	SCALE			
	$l \leq 10$	± 0.2	UNIT	mm		
	$10 < l \leq 30$	± 0.5	VER.			
	$30 < l \leq 100$	± 1.0	DATE	07/06/01		

RESISTANCE TAPER

TAPER B SERIES

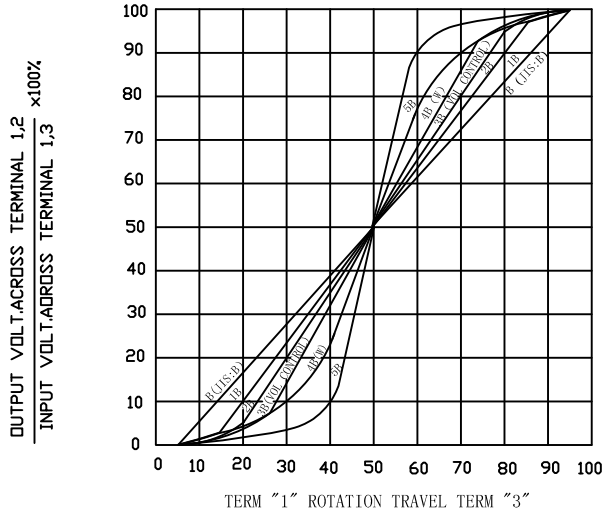

TAPER B WITH 50% TAP

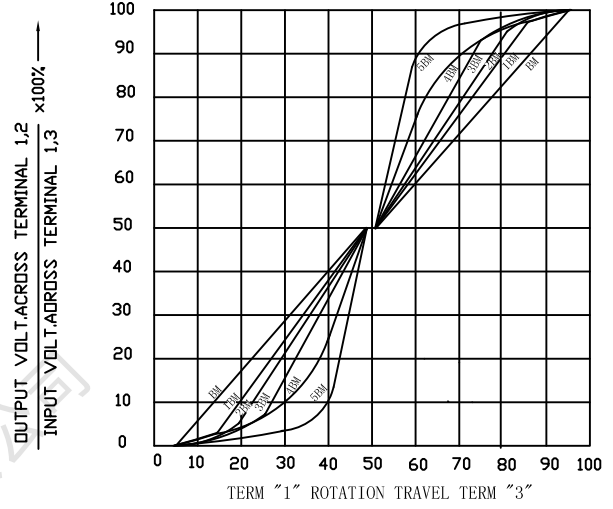

TAPER A SERIES

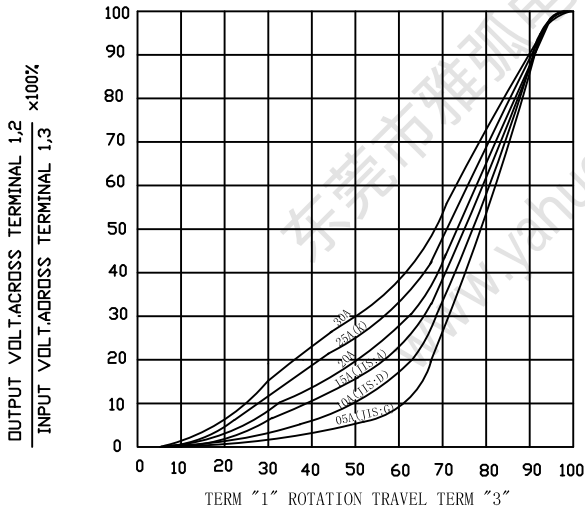

TAPER A & C WITH 50% TAP

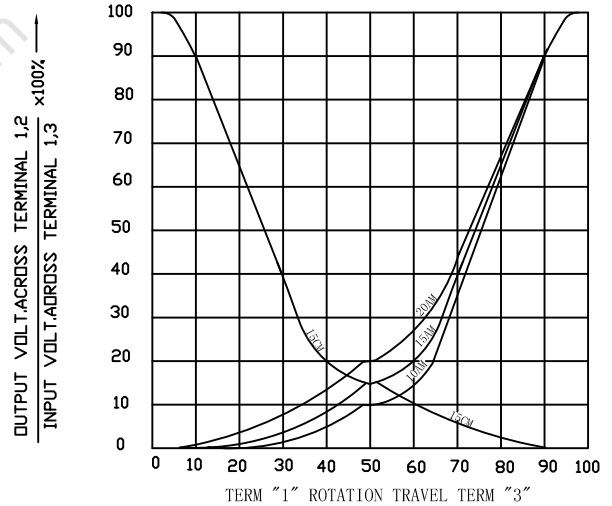

TAPER C SERIES

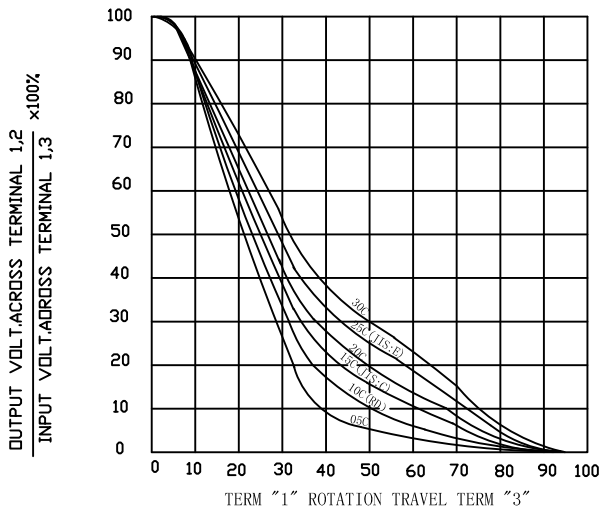

TAPER M & N SERIES

